

PHILIPS

EasyKey

3000 series

Smart Video Door
Lock

DDL303-VP-5HWS

User manual

Register your product and get
support at
www.philips.com/support



Contents

1. Important Information	02	6. Other features	19
Safety		One-click mute	
Caution		Restore to default settings	
Disposal of used products and batteries		Doorbell	
		Display	
<hr/>		<hr/>	
2. Installation	03	7. Indicators	21
Packing list		Door lock status indicator	
Exploded views		Mute indicator	
Pre-install instruction		System lock-up indicator	
Installation steps			
<hr/>		<hr/>	
3. Get to know the product	09	8. Troubleshooting	22
Outside escutcheon		Alert types & methods	
Inside escutcheon		How to apply an external power supply	
		How to replace batteries	
		How to charge the batteries	
<hr/>			
4. Settings	10		
Master mode			
Master settings			
User settings			
System settings			
Network settings			
Information query			
Mechanical feature query			
<hr/>			
5. Get to use the product	16		
Outdoor/ indoor unlock			
Outdoor/ indoor lock			
Indoor deadlock			
Mechanical key open			

1. Important information

Safety

- ◆ Before using the product, be sure to read and fully understand all instructions. Damage caused by non-compliance with the instructions will not be covered in the warranty.
- ◆ Use only the manufacturer-specified accessories/components.
- ◆ Use only the alkaline or Li-polymer batteries the product is equipped with, or use the same type of batteries with the same specification.
- ◆ Do not forcibly disassemble this product to avoid triggering an alarm or damaging the product.
- ◆ Do not scrape the fingerprint sensor with sharp objects, otherwise it may cause permanent damage.
- ◆ Do not expose products to the environment where there is water leakage or splashing.
- ◆ Do not expose the product to corrosive substances to prevent damaging the protective cover.
- ◆ Do not hang objects on the handle, in case it might affect the normal use of the lock.
- ◆ Please clean the product with a soft cloth.
- ◆ Do not remove the battery during setting up and operating.
- ◆ Please let a professional technician to install the door lock and follow the installation guidelines provided. Do not disassemble the lock by yourself. Keep the relevant sealed stickers properly.
- ◆ Please modify the default master PIN code immediately after installation and configuration, and keep the mechanical key properly, do not easily disclose the password to others.
- ◆ Please replace all the batteries immediately if there is a low battery level alarm. Please make sure to correctly match the poles (+/-) when installing the batteries.

Caution

- ◆ Do not place the batteries near fire sources to avoid explosion.
- ◆ Do not use any power supply that does not meet the safety requirements to power up the product.
- ◆ Do not connect the 2 poles of the batteries with metals to avoid short circuit which may lead to an explosion.
- ◆ Please make sure any component replacement is executed by Philips, Philips authorized service center or professional technicians.
- ◆ Do not use accessories or parts that have been produced by other manufacturers or have not been specifically recommended by Philips. The use of such accessories and parts may void your warranty.

Disposal of used products and batteries

- ◆ You can have your locks reclaimed at Philips authorized service centers. You will receive corresponding compensation if your products meet our conditions.
- ◆ Please familiarize yourself with the local electronic product collection system.
- ◆ Please follow local regulations and do not discard used products into ordinary household waste.
- ◆ Proper disposal of used products can help to avoid potential negative impacts on the environment and human health.
- ◆ Batteries must not be disposed of with ordinary household waste.
- ◆ Please familiarize yourself with the local regulations on batteries classification recycling. Disposing of batteries properly can help avoid a negative impact on the environment and human health.

2 Installation

Packing list

This packing list is for reference only. Please refer to the actual packing items.

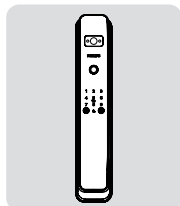

① Outside escutcheon with silicon pad

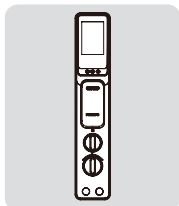

② Inside escutcheon with silicon pad

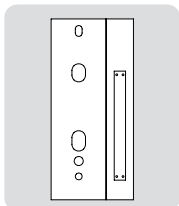

③ Drilling template

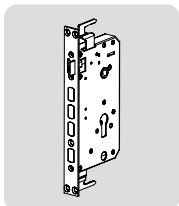

④ Mortise



⑤ User manual



⑥ Warranty card



⑦ Certificate of conformity

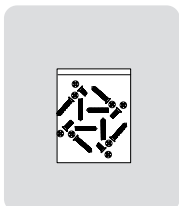

⑧ Installation kit

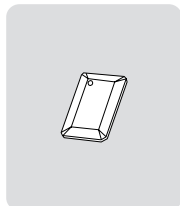

⑨ Key tag

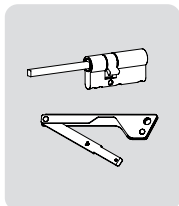

⑩ Mechanical key

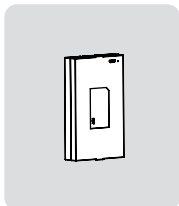

⑪ Li-ion battery

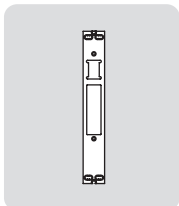

⑫ Strike

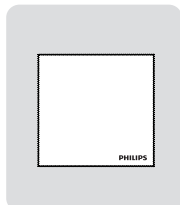

⑬ Cleaning pad

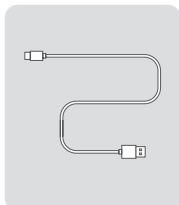

⑭ Charging cable

Exploded views

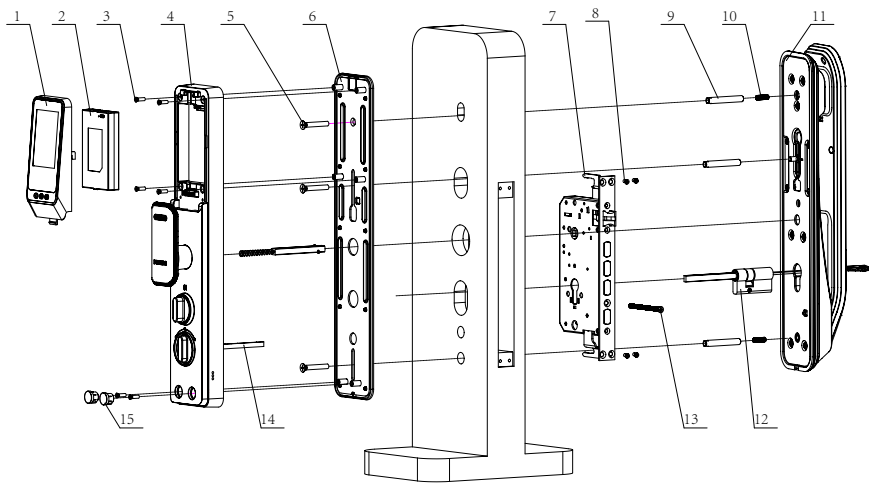

- | | | |
|------------------------------|-----------------------------------|--------------------------------------|
| 1. Screen*1 | 6. Rear sealing plate component*1 | 11. Outside escutcheon*1 |
| 2. Li-ion battery*1 | 7. Mortise*1 | 12. Lock cylinder*1 |
| 3. Inside escutcheon screw*6 | 8. Mortise's anchor screw*4 | 13. Lock cylinder's anchor screw*1 |
| 4. Inside escutcheon*1 | 9. M6 screw tube*3 | 14. Lock-out bolt bar*1 |
| 5. Anchor screw*3 | 10. Set screw*2 | 15. Inside escutcheon silicon plug*1 |

Pre-install instruction

Step 1 | Door opening direction

This product is suitable for doors with four opening directions: left-out pull, right-out pull, left-in push and right-in push.

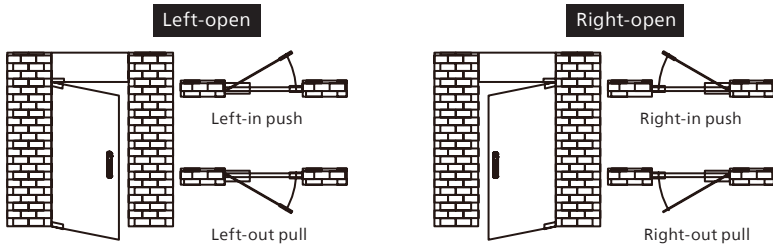

Step 2 | Changing the latch bolt's direction

You can change the direction of the latch bolt to adapt to doors of different opening directions. When the bolt bevel faces outside, it is for inwards opening; And when the bolt bevel faces inside, it is for outwards opening. There might be one of the two types of mortise attached, please follow the below steps to change the latch bolt's direction as per "Graph 1" or "Graph 2".

③ Pull out the latch bolt, rotate it to adjust the direction.

① Push the direction adjustment bar to the top.

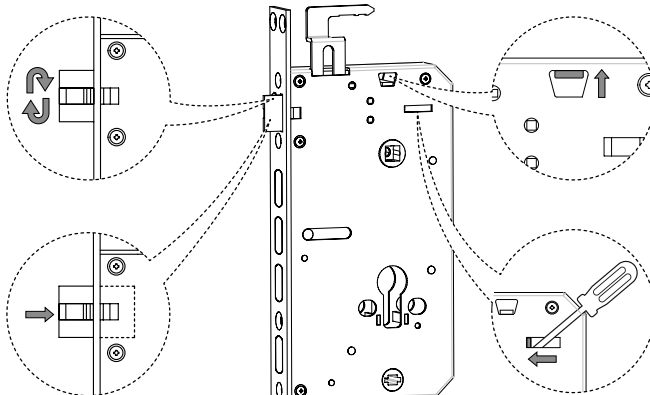

④ Follow the direction of the arrow to push the latch bolt in.

② Insert a screw driver to the slot, and use the screw driver to push the latch bolt's connecting rod to the direction of the latch bolt.

Graph 1

② Follow the direction of the arrow to rotate the latch bolt to 180 degrees.

① Follow the direction of the arrow to rotate the direction adjustment bar.

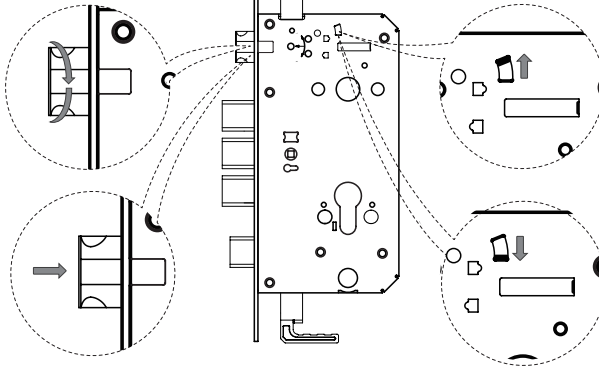

③ Follow the direction of the arrow to push the latch bolt in.

④ Follow the direction of the arrow to rotate the direction adjustment bar.

Graph 2

⚠ Attention

1. Choose a proper installation kit base on the door thickness.
2. The default installation kit is applicable to door thickness of 60-90mm. If your door thickness is out of this range, please contact the local distributor.

Installation steps

The following installation steps apply to right-open doors. For left-open doors, please read the [Pre-install instructions] carefully and make needed adjustments.

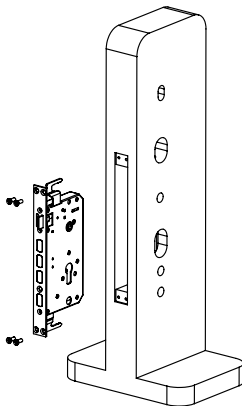

- 1 To drill the needed holes in the door as per the drilling template, then mount the mortise on the hole, and tighten the anchor screws to fix the mortise.

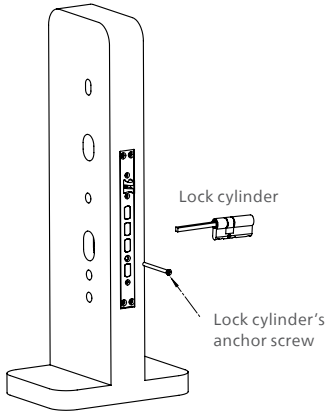

- 2 Put the lock cylinder into the mortise, and then tighten the lock cylinder's anchor screw.

Attention

1. Please cut the bar of the lock cylinder to a proper length.
2. Cutting requirements: After the lock cylinder is inserted into the mortise, leave the bar with an extruded length of 15-30mm that is higher than the door surface and cut the rest part. When the cutting is done, align the mortise to put the lock cylinder into it.

- 3 Install the set screw and connecting screw tube on the outside escutcheon.

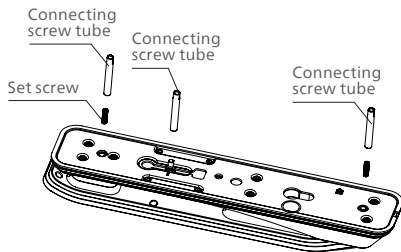

- 4 Pass the connecting cable through the hole above the door. Align the square shaft of the outside escutcheon with the rotary hole on the mortise, and insert the square shaft into the rotary hole, so that the outside escutcheon is closely fitted in the outside part of the door.

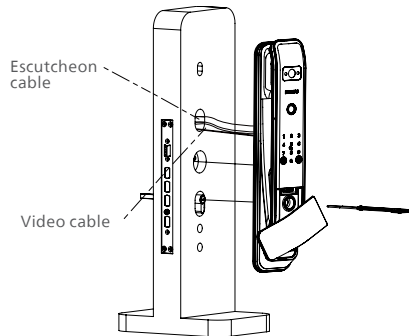

- 5 Attach the fixing plate to the inner surface of the door, fix it with 3 M6 anchor screws, and tighten them.

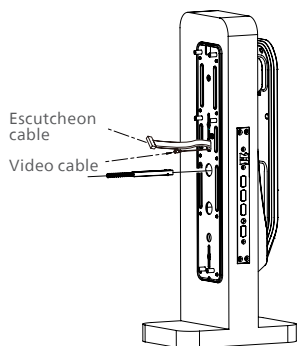

- 6 Insert the cut lock-out bolt bar into the buckle of the inside escutcheon, then connect the escutcheon cable and video cable accordingly.

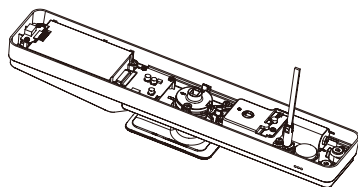

Attention

Please cut the length of the lock-out bolt bar to a proper length as per the door thickness.

- 7 Align the square shaft of the lock cylinder and the lock-out bolt bar with the corresponding socket on the inside escutcheon, hide the extra cables into the door hole, and stick the inside escutcheon tightly to the door. Tighten the anchor screws to fix the inside escutcheon.

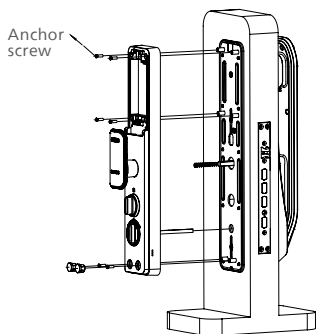

- 8 Install the battery and screen component.

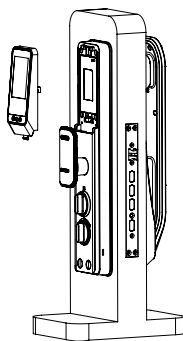

- 9 To check whether the rotary knob, mechanical keys, and all other parts are well connected or not.

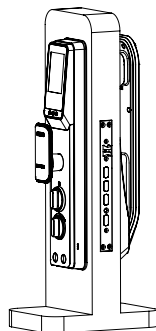

3 Get to know the product

This packing list is for reference only. Please refer to the actual packing items.

Outside escutcheon

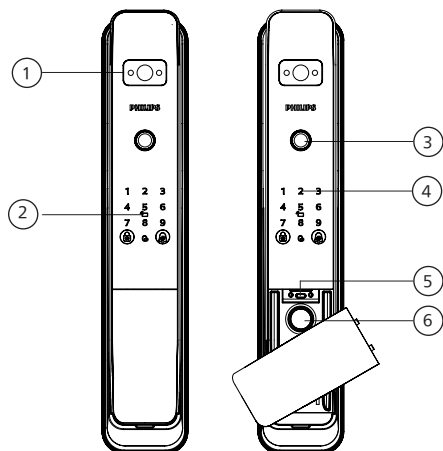

①	Camera
②	Card reader
③	Fingerprint sensor
④	Keypad
⑤	Micro USB port
⑥	Mechanical key hole

Inside escutcheon

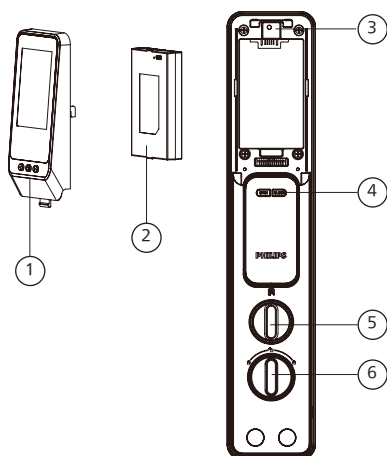

①	Screen
②	Battery
③	RES button
④	OPEN/CLOSE button
⑤	Unlock rotary knob
⑥	Lock-out bolt bar's rotary knob

4 Settings

Pre-setup instructions

- ◆ There are 2 operating modes for the product: general mode and dual verification mode.

General mode	Unlock by any enrolled verification method.
Dual verification mode	Unlock by any two of the verification methods among PIN code, key tag and fingerprint.

- ◆ User code

You can delete a single user information by its user code without having to delete everything in the system.

You can fill in the user information in the following table for future query:

Code	Name	Fingerprint	PIN code	Key tag
00				
01				
02				
03				
04				
05				
06				

- ◆ Icon annotation

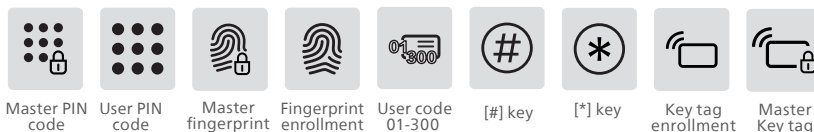

⚠ Attention

1. Press [*] key to return to the previous menu.
2. In the initial state, any fingerprint, key tag or 8-digit or above PIN code can unlock the door.
3. Total capacity of verification access is 300 sets- Fingerprint: 100 sets; PIN code: 100 sets; Key tag: 100 sets.

Master mode

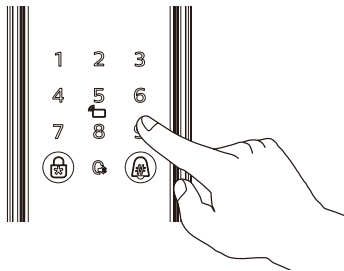

Wake up the keypad and long press the [#] key to enter the master mode.

⚠ Attention

In the initial state, there is no master information. You need to add a master before moving on to the next steps.

Master settings

Add an admin



Long press [#] key, enter any of the master access methods (including master fingerprint, master PIN code, or master key tag), to enter the master mode.



Press [1] to enter master mode, then press [1] again to add an admin, and the door lock will automatically recognize the unlocking methods and add PIN codes/fingerprints/key tags accordingly.



Add a PIN code: enter the master PIN code and confirm with [#] key, re-enter the master PIN code and re-confirm with [#], and the voice will prompt that the addition is successful.

Add a fingerprint: place the finger on the fingerprint sensor, follow the voice prompts to lift and re-place the finger on the fingerprint sensor until the voice prompts that the addition is successful.

Add a key tag: Follow the voice prompts to enroll the key tag until the voice prompts that the addition is successful.

⚠ Attention

1. The user code range from 1 to 9 belongs to master users (and the master users' verification method could be a fingerprint, PIN code or key tag).
2. The PIN code length is 8 digits.

Delete an admin



Long press [#] key, enter any of the master access methods (including master fingerprint, master PIN code, or master key tag), to enter the master mode.



Press [1] to enter master settings, follow by pressing [2] to delete a master user, then delete the user codes of the master PIN code, master fingerprint or master key tag that need to be deleted, and confirm with [#] key, and the voice will prompt that the operation is successful.

User settings

Add a user



Long press [#] key, enter any of the master access methods (including master fingerprint, master PIN code, or master key tag), to enter the master mode.



Press [2] to enter user settings, then press [1] again to add a user, and the door lock will automatically recognize the unlocking methods and add PIN codes/fingerprints/key tags accordingly.



Add a PIN code: enter a new user PIN code and confirm with [#] key, re-enter the user PIN code and re-confirm with [#], and the voice will prompt that the addition is successful.

Add a fingerprint: place the finger on the fingerprint sensor, follow the voice prompts to lift and re-place the finger on the fingerprint sensor until the voice prompts that the addition is successful.

Add a key tag: Follow the voice prompts to enroll the key tag until the voice prompts that the addition is successful.

⚠ Attention

1. The user code range from 10 to 300 belongs to general users(and the general users' verification method could be a fingerprint, PIN code or key tag).
- 2.The PIN code length is 8 digits.

Delete a user



Long press [#] key, enter any of the master access methods (including master fingerprint, master PIN code, or master key tag), to enter the master mode.



Press [2] to enter user settings, then press [2] to enter user deletion. To delete a specific user, press [1] and enter the corresponding code of the user PIN code, fingerprint, or key tag, then press [#] to confirm the deletion. You will hear a voice prompt confirming the successful deletion. To delete all users, press [2] and press [#] to confirm the deletion. You will hear a voice prompt confirming the successful deletion.

System settings

Time settings



Long press [#] key, enter any of the master access methods (including master fingerprint, master PIN code, or master key tag), to enter the master mode.



Press [3] to enter system settings, then press [1] to enter time settings, the lock will automatically prompt the current time, and the user can follow the voice prompts to finish the time settings.

Lock code settings



Long press [#] key, enter any of the master access methods (including master fingerprint, master PIN code, or master key tag), to enter the master mode.



Press [3] to enter system settings, then press [2] to enter lock code settings, the lock will prompt the current lock code, then the user can follow the voice prompts to enter a 3-digit or 4-digit lock code and confirm with [#] key, the voice prompt that the operation is successful.

Voice settings

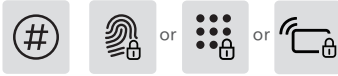

Long press [#] key, enter any of the master access methods (including master fingerprint, master PIN code, or master key tag), to enter the master mode.



Press [3] to enter system settings, re-press [3] to enter voice settings, then follow the voice prompts to choose [6] or [4] to adjust the voice volume accordingly.

Unlock mode



Long press [#] key, enter any of the master access methods (including master fingerprint, master PIN code, or master key tag), to enter the master mode.



Press [3] to enter system settings, then press [4] to enter unlock mode settings, for single-factor unlock method, please press [1]; for combined-factor unlock method, please press [2]; for latch bolt re-lock time settings, please press [3], and follow by below steps to set the latch bolt re-lock time.



To add latch bolt re-lock time, please press [2]; to reduce latch bolt re-lock time, please press [8].

⚠ Attention

1. The latch bolt re-lock time refers to the set time of how much time the latch bolt will rebound after the door unlocked, and the default latch bolt re-lock time is 3s.
2. The range of the latch bolt re-lock time is from 1 to 9 seconds, each time could only adjusted by 1s.

Delayed locking settings



Long press [#] key, enter any of the master access methods (including master fingerprint, master PIN code, or master key tag), to enter the master mode.



Press [3] to enter system settings, then press [5] to enter delayed locking settings, for longer delayed locking time, please press [2], for shorter delayed locking time, please press [8].

⚠ Attention

1. The default locking time is 10s.
2. The range of the locking time is from 0 to 90 seconds, each time could only adjusted by 10s.

Language settings



Long press [#] key, enter any of the master access methods (including master fingerprint, master PIN code, or master key tag), to enter the master mode.



Press [3] to enter system settings, then press [6] to enter language settings.



Please select the language needed: for Chinese, press [1]; for English, press [2]; for Spanish, press [3]; for Arabic, press [4]; for Kazakh, press [5]. Once the voice prompts operation is successful, press [*] back to the previous menu until exiting the master mode.

Network settings



Long press [#] key, enter any of the master access methods (including master fingerprint, master PIN code, or master key tag), to enter the master mode. 

4 1

Press [4] to enter network settings, for hot-spot connection, please press [1], for auto connection, please press [2].

Attention

This product is a connected door lock, users can use the connected features by binding the product with [Smart Life] App, and users can download [Smart Life] App on Appstore. 

Information query

Log query



Long press [#] key, enter any of the master access methods (including master fingerprint, master PIN code, or master key tag), to enter the master mode. 

5 1 2 or 8

Press [5] to enter information inquiry, and select [1] for log inquiry. The lock will report the latest log information. Follow the voice prompts to enter the date for the query and the lock will report the operation records of that day. You can follow the voice prompts for operation, for scrolling up the logs, please press [2], for scrolling down the logs, please press [8]. 

Attention

Door lock operation logs <510 articles.

Storage query



Long press [#] key, enter any of the master access methods (including master fingerprint, master PIN code, or master key tag), to enter the master mode. 

5 2

Press [5] to enter information query, and select [2] for storage query. The lock will report the current number of registered fingerprints, PIN codes, and key tags, and also the remaining volume for access method storage through voice prompts. 

Attention

1. Code range from 01~09 belong to master users;
2. Code range from 10~300 belong to general users;

Version query



Long press [#] key, enter any of the master access methods (including master fingerprint, master PIN code, or master key tag), to enter the master mode. 

5 3

Press [5] to enter information query, for version query, please press [3], then you will hear a voice prompts the current version of the lock. 

Motor settings

The motor settings only for installation technicians, please operate it carefully.

Torque settings



When the door lock is in the initial state, wake up the door lock keypad and press "888#" to enter the motor setting mode. Press [1] to enter the torque setting, then press [1], [2] or [3] to select the required torque, and there will be a voice prompt of the currently selected torque, then the setting is done.

Door swing direction settings



When the door lock is on the left side of the door, under the initial state, wake up the keypad and press "888#" can enter the motor setting mode. Press [2] to enter the torque setting, re-press [2] to set the left swing door direction, and the voice will prompt the door is left-open.

When the door lock is on the right side of the door, under the initial state, wake up the keypad and press "888#" can enter the motor setting mode. Press [2] to enter the torque setting, re-press [2] to set the right swing door direction, and the voice will prompt the door is right-open.

Reversal period settings



Under the initial state, wake up the keypad and press "888#" can enter the motor setting mode. Press [3] to enter reversal period settings, then press [2] to add the reversal period, or press [8] to reduce the reversal period settings. After the settings is done, the voice will prompt: the reversal period is XXX seconds.

Attention

The default reversal period is 0.4 seconds. It could be adjusted from 0.2 to 0.5 second. 

5 Get to use the product

Unlock from outside / inside

Unlock from outside

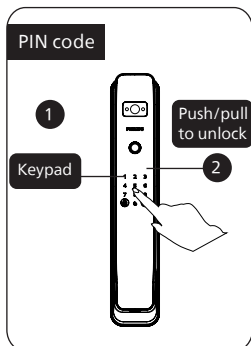

① Touch to wake up the keypad, enter the enrolled PIN code and confirm with [#] key.

② After the voice prompts "door unlocked", push or pull the handle to unlock the door.

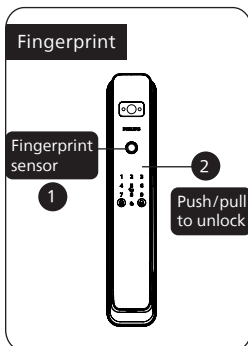

① Place the enrolled finger to the fingerprint sensor.

② After the voice prompts "door unlocked", push or pull the handle to unlock the door.

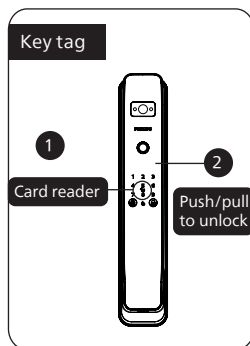

① Place the enrolled key tag on the card reader.

② After the voice prompts "door unlocked", push or pull the handle to unlock the door.

Unlock from inside

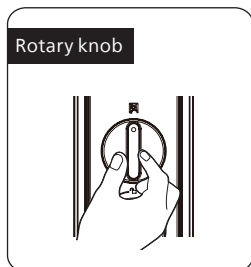

Pull the rotary knob outward and rotate it to unlock the door.

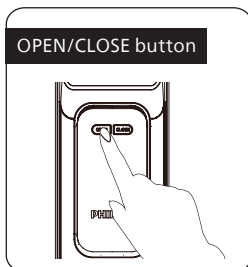

Click the [OPEN] button and then push or pull the door to unlock.



Hold and rotate the handle can unlock the door from inside.

⚠ Attention

The door lock will not be locked automatically after using the "rotary knob" or the "handle" to unlock the door. If you are inside the house, please use the "CLOSE" button to lock it. If you are outside the house, please press the "lock" icon on the outside escutcheon to lock it.

Lock from outside/inside

Auto-locking

When the door is closed, the lock will be locked automatically.

⚠ Attention

The auto-locking period is related to the delayed locking period, please follow your own usage habit to set the locking period.

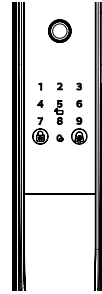

Manually locking

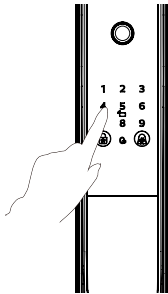

When the auto-locking of the door lock fails occasionally and cannot be automatically locked. After closing the door, please press the lock button on the outside escutcheon to complete the locking step.

⚠ Attention

The [*] key could be used as both a lock button and a [*] key, when the keypad is lightened up, long press the [*] key for 2s, the [*] button could be used as a lock button; short press the [*] key could go back to the previous page.

OPEN/CLOSE button locking

When the auto-locking of the door lock fails occasionally and cannot be automatically locked. After closing the door, please press the CLOSE button to complete the locking step.

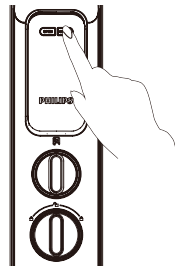

Handle locking

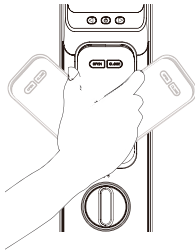

Hold and rotate the handle can unlock the door from inside.

Indoor deadlock

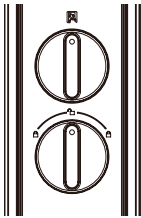

When the door lock is locked, press down and rotate the rotary knob to the left or the right side's lock scale (as shown on the left graphic) could enable indoor deadlock. On the contrary, rotate the knob to the unlock scale in the middle could disable the indoor deadlock.

Mechanical key unlock

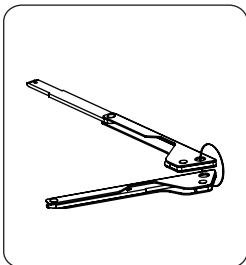

① Get the mechanical keys from the packing.

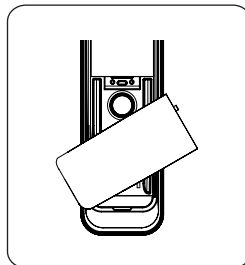

② Open the mechanical key cover from the bottom of the outside escutcheon, and rotate the bottom part of the cover until the keyhole unveils.

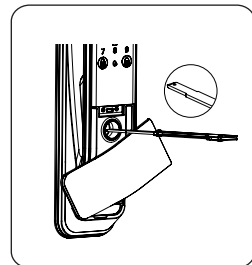

③ Insert the key into the lock cylinder, push hard and rotate it to unlock.

6 Other features

One-click mute

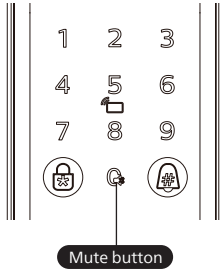

function:

Users can enable one-click mute to disable the voice prompts, which applies to the scenario that you don't want your family to be disturbed.

How to use:

(1)Switch to mute mode: when the system is waken up, long press the mute button for 2s to enter mute mode, and the indicator will be in white.

(2)Switch to voice mode: when the system is waken up, long press the mute button for 2s to resume to voice mode, and the indicator will be in white.

Default settings

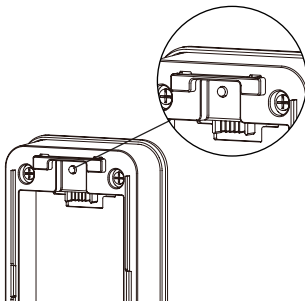

function:

Empty all user information and restore to default settings.

How to use:

Long press the [RES] button with a sharp object for 6s, and confirm with [#], then all the user information will be emptied. The lock will be restored to default settings.

Doorbell

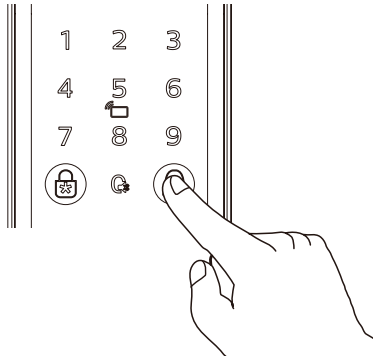

function:

The indoor speaker emits a ding-dong sound to remind the host that a visitor is arrived.

How to use:

Press the doorbell from outside, the indoor speaker will emit a ding-dong sound. Simultaneously, the camera of the door lock will capture the visitor's photo, and send the captured content to the bond WeChat Mini Program. After the WeChat Mini Program receives the push message, you can remotely view the captured content of the doorway and unlock the door accordingly.

⚠ Attention

The [#] key could be used both as a doorbell button and a [#] key, when it is under sleep mode, press the [#] key is to ring the doorbell, after the keypad is waken up, when you press the [#] key, it is for confirming.

Display

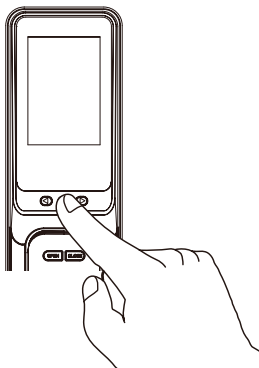

function:

When the visitor rings the doorbell, users can check the doorway from the indoor display.

How to use:

When a visitor rings the doorbell, you can click the indoor screen button to turn on the display, and you can also view the doorway through the screen.

7 Indicator annotation

Door lock status indicator

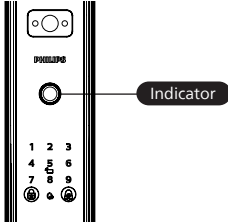

Blue:

indicating that fingerprinting could be processed;

Green:

indicating that verification is succeeded, and unlocking is allowed;

Red:

indicating that verification failed or alert is triggered.

Mute indicator

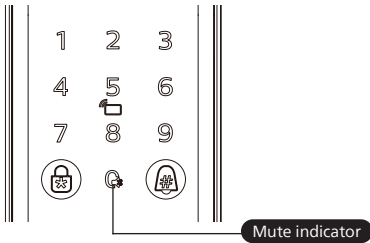

Note:

White: whether the mute mode is on or off, the indicator is in white.

System lock-up indicator

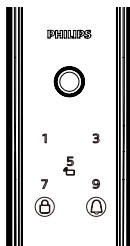

If there are 5 consecutive incorrect inputs of any of the 3 types of verification methods (fingerprint/PIN code/key tag), the system will be locked for 3 minutes.

Attention

Only when touching to wake up the keypad or verifying the unlock methods will the system appears such a system lock-up prompt.

8 Troubleshooting

Alert types & methods

Anti-dismantling alert

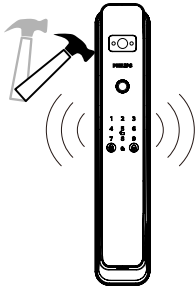

Triggering: when the outside escutcheon is being pried open and the outside escutcheon is not closely fit with the door.

Alert mode: continuous repeated alert.

Off: the alert will turn off automatically, turn off after any successful unlock verification from outside or a successful unlock from inside.

How to apply an external power supply

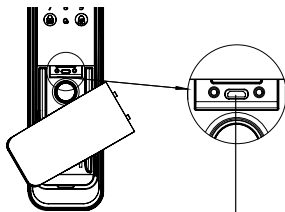

External power supply interface

When the battery voltage is insufficient, and the door cannot be opened from the outside, you can power up the lock through the Micro USB interface by using a 5V power bank as an external power supply. After opening the door lock, please replace the batteries immediately.

In case of a system crash and it's unable to open the door from outside, please use an external power supply to power up the door lock, then it can be reboot automatically.

How to replace batteries

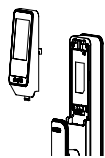

Slide up to open the battery cover

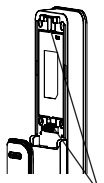

Battery cover buckle

The working power of the door lock is a 4200mA/h lithium battery. The battery cabinet is located at the upper end of the inside escutcheon. You can slide the battery cover upwards and remove the cover to replace the battery.

How to charge the batteries

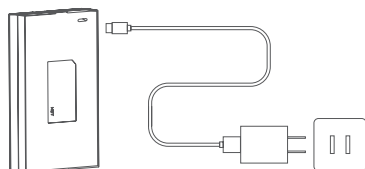

When the battery voltage is insufficient, and the door cannot be opened from the outside, you can power up the lock through the Micro USB interface by using a 5V power bank as an external power supply. After opening the door lock, please replace the batteries immediately.

⚠ Attention

1. The warranty period for the Li-ion battery is 1 year.
2. The charging voltage is 5V.
3. When the network in the use environment is unstable, it will accelerate the battery's power consumption.



Philips and the Philips Shield Emblem are registered trademarks of Koninklijke Philips N.V. and are used under license. This product has been manufactured by and is sold under the responsibility of Shenzhen Conex Intelligent Technology Co., Ltd. and Shenzhen Conex Intelligent Technology Co., Ltd. is the warrantor concerning this product.